



**Single & Paired
Swinging
MODELS -120/125,
130/135, 220/225,
230/235**

PARTS MANUAL

Instructions for Ordering

This parts manual is intended to assist in the correct identification of the more commonly replaced parts; covering, generally, all models and styles offered within the marathon pharm. Line. The manual will also help identify obsolete parts, part design changes and current production parts. For more specific parts information, please contact an authorized representative or consult the factory's customer service or engineering departments. Asi doors reserves the right to discontinue any part and make design changes without notice.

General Instructions for Ordering Door Parts

Accurate information is always necessary to serve you correctly and promptly. Several steps should be followed to determine exactly the parts that are needed.

Refer to the information tag on your door and record the:

1. Door model number
2. Job number
3. Door number
4. Manufacturing date.

Use part numbers referenced in this manual.

If the item is not found in the manual, the product code on the back of the item is helpful.

If your door has no information label, the approximate purchase date is helpful.

Call

1-800-558-7068

or visit

asidoors.com/parts

to order parts

Manual Part #: 17A144

Door Assembly, Single

All Single Doors, Manual & Power

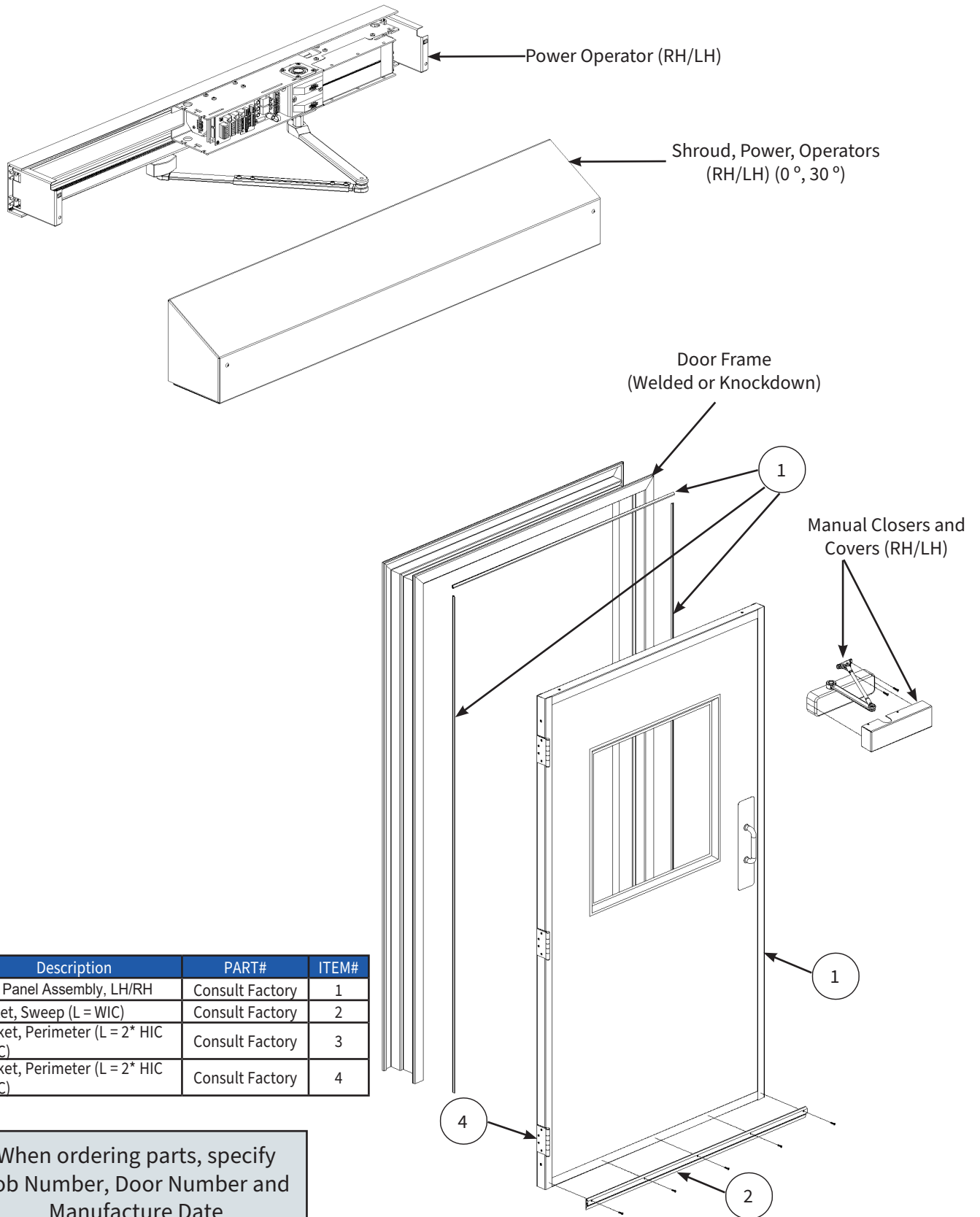

REPLACEMENT PARTS

Description	PART#	ITEM#
Door Panel Assembly, LH/RH	Consult Factory	1
Gasket, Sweep (L = WIC)	Consult Factory	2
Gasket, Perimeter (L = 2* HIC +WIC)	Consult Factory	3
Gasket, Perimeter (L = 2* HIC +WIC)	Consult Factory	4

When ordering parts, specify Job Number, Door Number and Manufacture Date

Door Assembly, Paired

All Paired Doors, Manual & Power

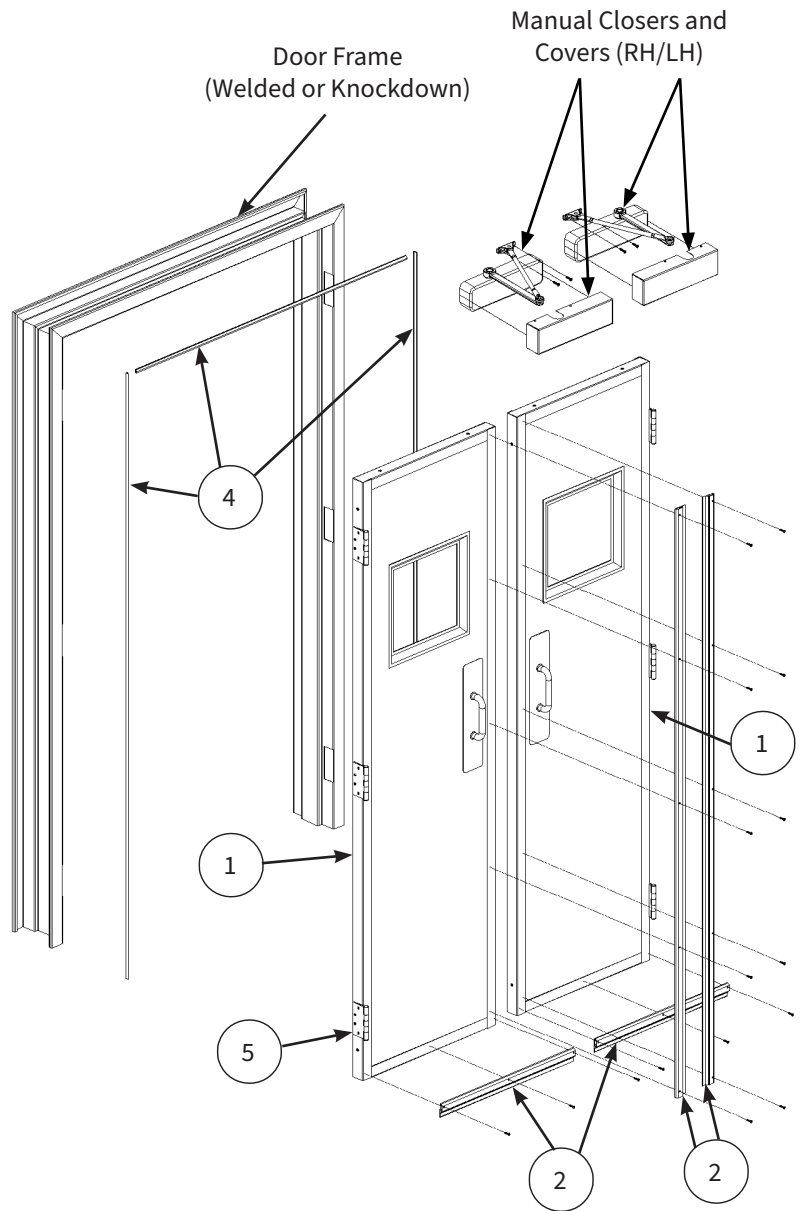
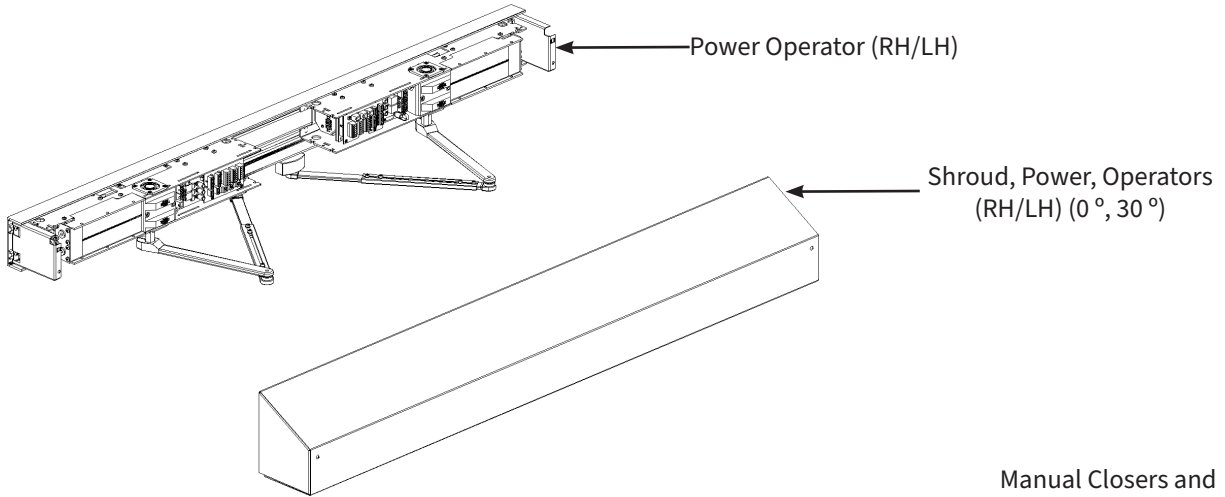

Description	PART#	ITEM#
Door Panel Assembly, RH	Consult Factory	1
Door Panel Assembly, LH	Consult Factory	2
Gasket Sweep (L=WIC/2)	Consult Factory	3
Gasket, Perimeter (L = 2* HIC +WIC)	Consult Factory	4
Hinge	Consult Factory	5

When ordering parts, specify Job Number, Door Number and Manufacture Date

REPLACEMENT PARTS

Door Panel

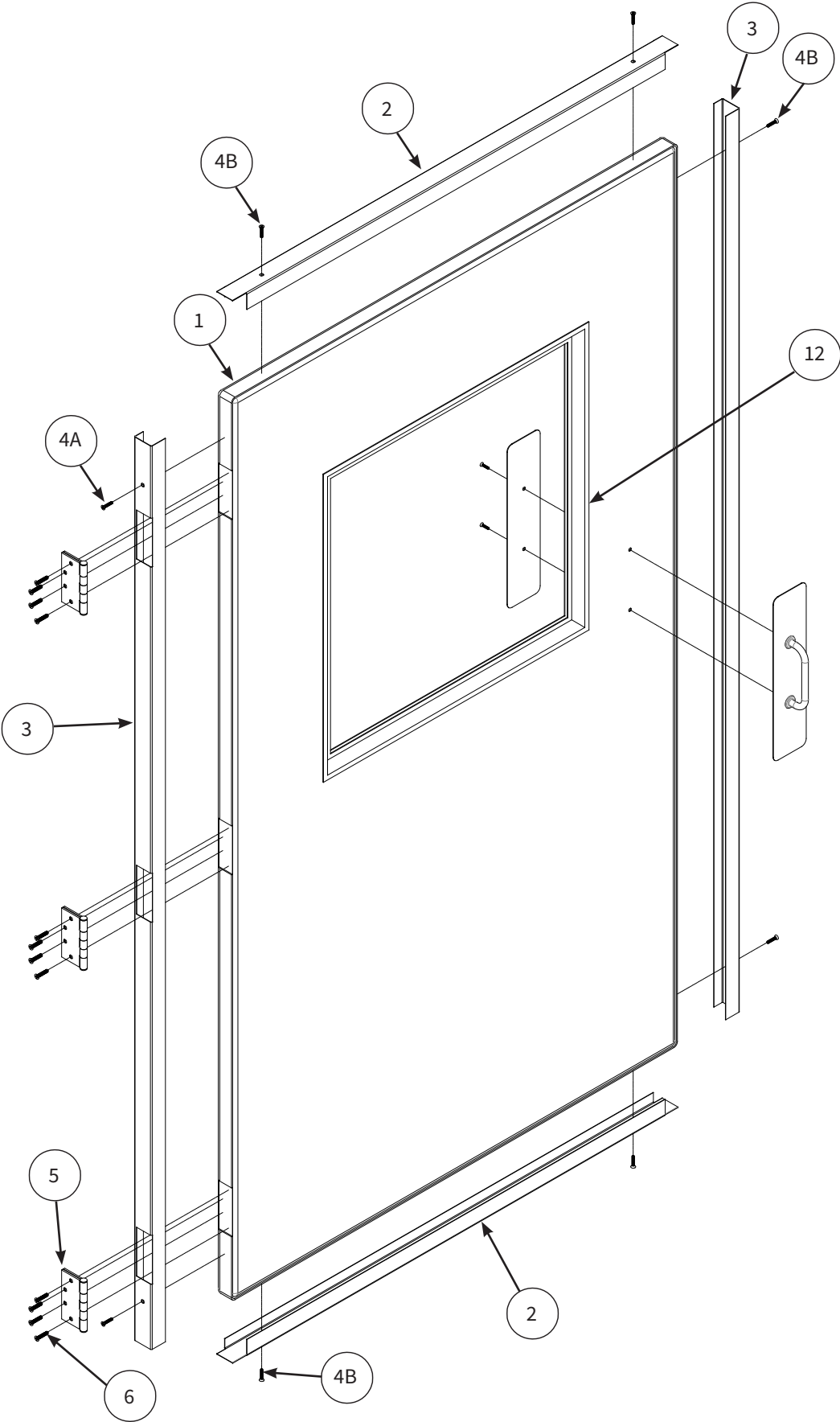

REPLACEMENT PARTS

Header Assembly

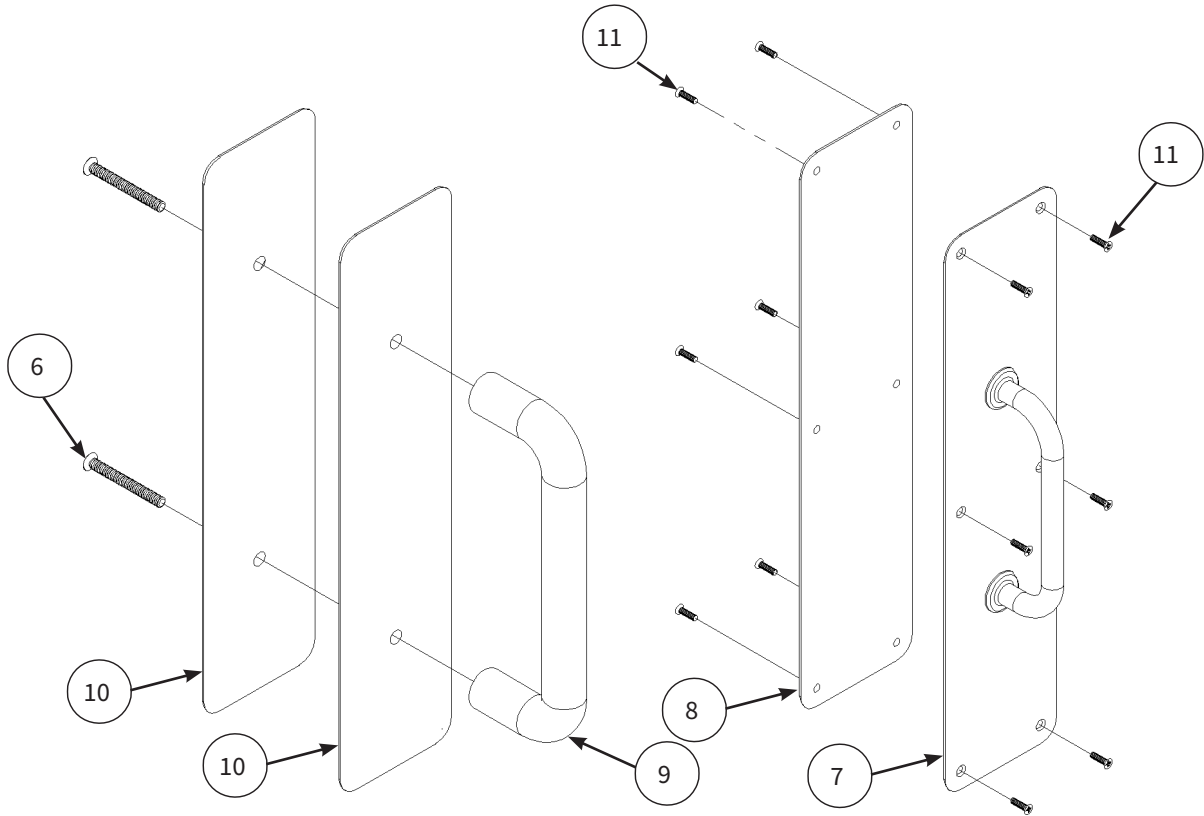

Description	PART#	ITEM#
Door Panel Assembly, RH	Consult Factory	1
Door Panel Assembly, LH	Consult Factory	1
Capping, Panel, Top/Bottom (As Required)	Consult Factory	2
Capping, Panel, Side (As Required)	Consult Factory	3
Screw, #10-24 x 1.00, PH FH MS, S/S (Hinge Side)	41A199	4A
Screw, #10-24 x 1.00, PH FH SMS, S/S (Non-Hinge Side)	41A794	4B
Hinge	Consult Factory	5
Screw, #12-24 x 1.00, PHL FHMS, S/S	41A656	6
Push Plate, W/ Handle (Optional, Pre-2010)	16B017	7
Push Plate (Optional, Pre-2010)	16B016	8
Handle, Stainless (STD)	16B0085NN	9
Push Plate, Stainless (STD)	16B022	10
Screw, #6-32 x 0.75, PHL FHMS, S/S	41A655	11
Window Asm, 1-3/4", Pharm Panel (Optional)	55B575	12
Window Asm, 1-3/4", Cleanview (Optional)	55B400	12

When ordering parts, specify
Job Number, Door Number and
Manufacture Date

Operator and Shroud

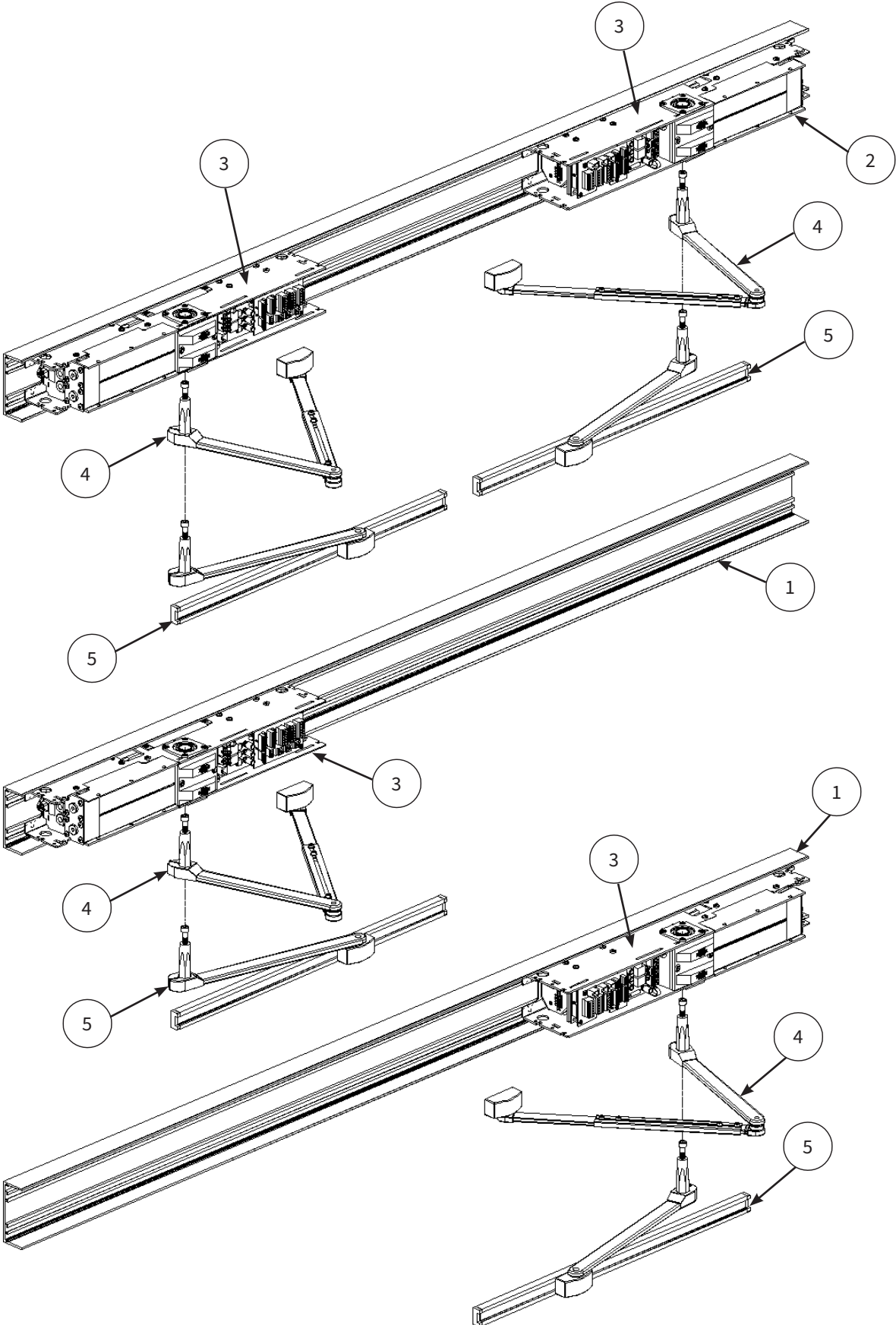

REPLACEMENT PARTS

Operator and Shroud

Description	PART#	ITEM#
Asm, Operator, Inswing, Single, LH	30D0040LV	1
Asm, Operator, Inswing, Single, RH	30D0040RV	1
Asm, Operator, Outswing, Single, LH	30D0041LV	1
Asm, Operator, Outswing, Single, RH	30D0041RV	1
Asm, Operator, Inswing, Paired	30D0042NV	2
Asm, Operator, Outswing, Paired	30D0043NV	2
Operator, 1301	23B0147	3
Outswing Arm Assembly, Aluminum	16B0094NN	4
Outswing Arm Assembly, 0"- 4", Stainless	16B0098NN	4
Outswing Arm Assembly, 4"- 10", Stainless	16B0097NN	4
Inswing Arm & Track Assembly, Aluminum	16B0095NN	5
Inswing Arm & Track Assembly, Stainless	16B0096NN	5
Manual Closer, RH/LH	Consult Factory	6
Closer Cover, S/S	Consult Factory	7
Screw, 10-24 x 1/2", PH, PHMS, S/S	41A618	8
Bracket, Shroud, Power Swing, 304 / 316 Stainless	13B2485NN20 / 25	9
Asm, Single RJ12 Connector	24B0725	10
Asm, Paired RJ12 Connectors	24B0726	11
Cable, LIN BUS, 7 FT	23A0371NN	12
Programming Keypad (Loose)	23A0363	13
Shroud, 30°, Single Swing	55B0125	14
Shroud, 30°, Paired Swing	55B0126	15
Shroud, 0°, Single Swing	55B0127	16
Shroud, 0°, Paired Swing	55B0128	17

When ordering parts, specify Job Number, Door Number and Manufacture Date

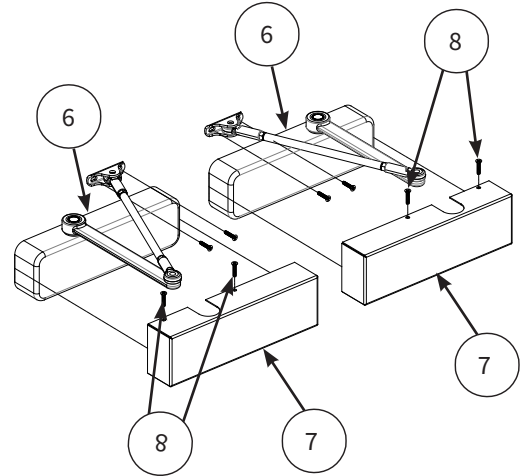

NOTE

Note sloped shrouds shown for reference. Shrouds are also available in flat top design. Consult factory for specific Shroud P/N's.

REPLACEMENT PARTS

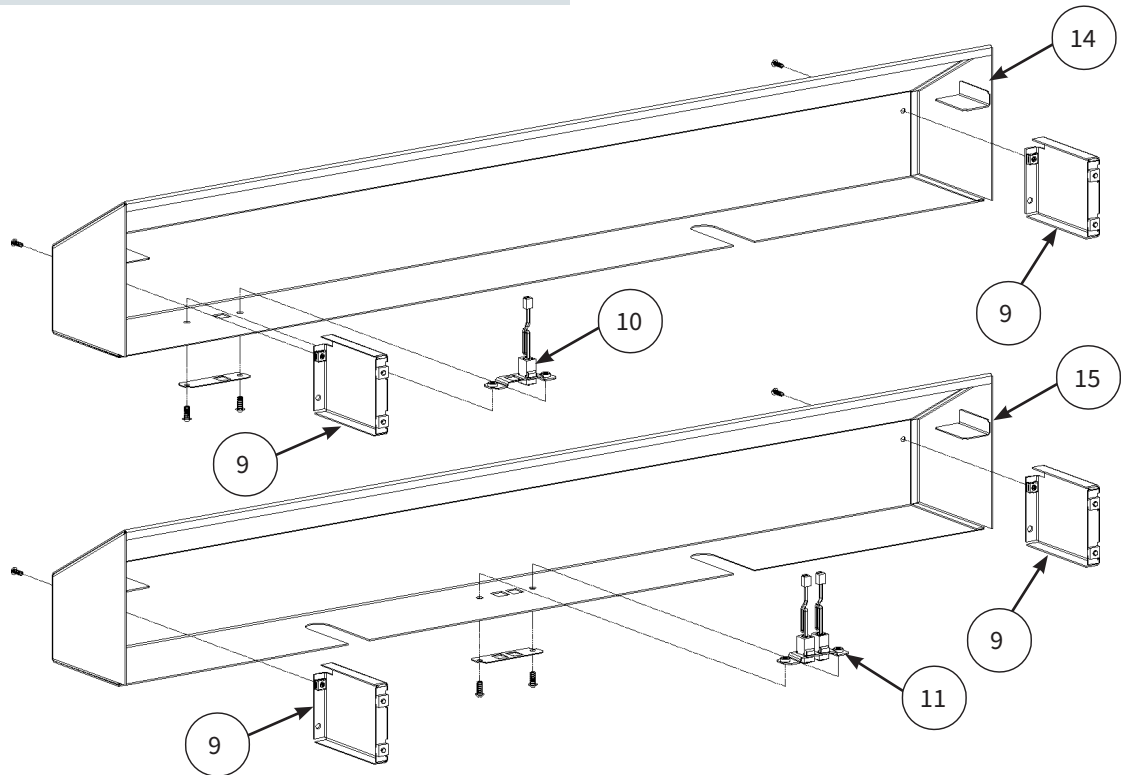



OPEN UP TO WHAT'S POSSIBLE



asidoors.com